

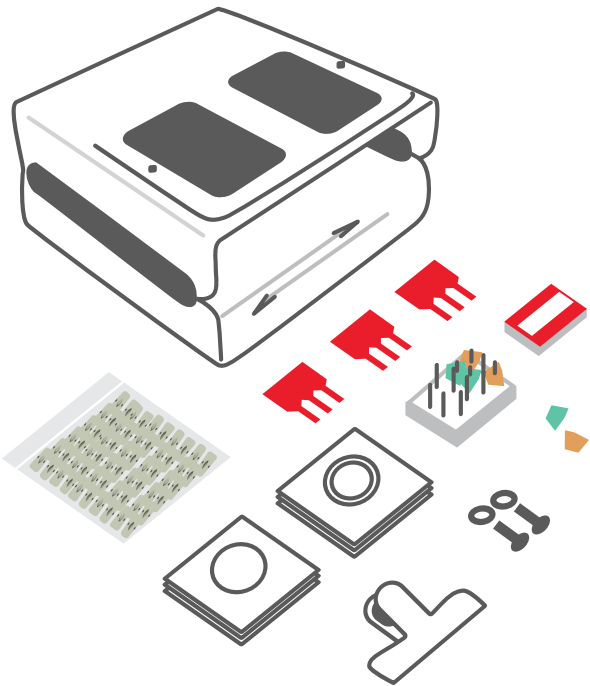

USER GUIDE



FUNDAMENTALS OF LAPAROSCOPIC SURGERY™ TRAINER SYSTEMS

FLS™

LEARN MORE AT

fls-products.com

INDEX

PACKAGE SUPPLIED	3
TEST CERTIFICATION	4
SAFETY & CLEANING INSTRUCTIONS	6
SET UP	7
• ATTACHING THE TROCARS	7
• ATTACHING THE FRAME	8
• ASSEMBLING THE TRAINER BOX	8
• CONNECTING A MONITOR	9
TIPS	10
• ADJUSTING THE CAMERA TO CENTER THE IMAGE	10
• REMOVE PLASTIC CAP	11

THREE SYSTEMS AVAILABLE

FLS Trainer Box

50302

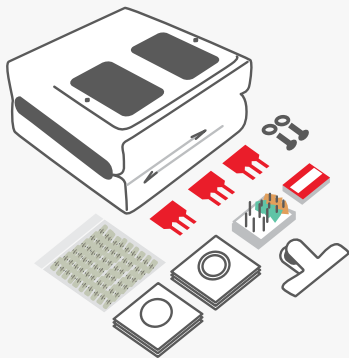

FLS Trainer System

50304

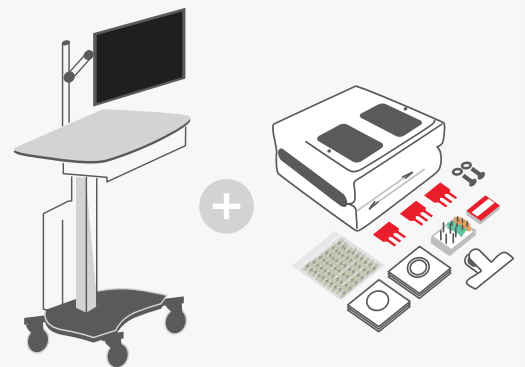

FLS All-In-One Trainer System

50306



PACKAGE
SUPPLIED

TRAINER BOX TOP

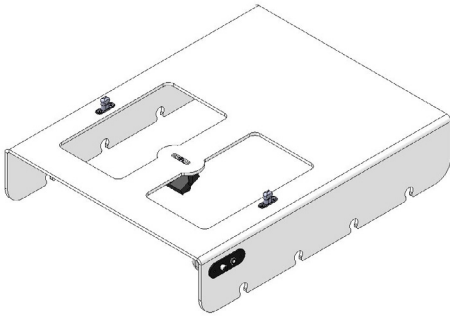

TRAINER BOX BASE

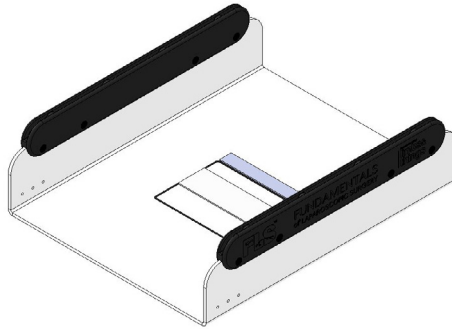

SKIN FRAME

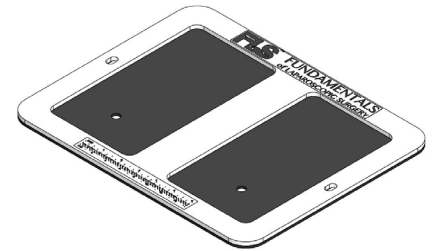

TROCARS

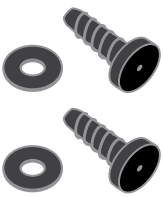

CAMERA



MONITOR CABLE



POWER CABLE
& ADAPTORS



STRING
& ALLIGATOR CLIPS



ACCESSORIES

Peg Board with 6 Triangles



Suture Block



Jumbo Clip Retainer



CONSUMABLES

3 Foam Organs



50 Penrose Drains

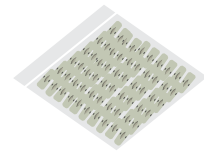

25 Gauze Pads with Single Circle



25 Gauze Pads with Double Circle



Single Use Ligating Loop (Pack of 3)*



Multi-Use Ligating Loop (Pack of 5)*



* ONLY 50306 All-In-One Trainer System

TEST
CERTIFICATION



EC DECLARATION OF CONFORMITY

In accordance with ISO IEC 17050-1 : 2010

We at
Limbs & Things Ltd

of

Sussex Street, St. Philips, Bristol, BS2 0RA

Declare under our sole responsibility that the product described below:

Brand and Model Name	FLS (Fundamentals of Laparoscopic Surgery) Trainer, Part numbers: 50301,50302, 50306
----------------------	--

Has been tested and is in conformity with the following standards:

SUBJECT	STANDARD
Electrical Safety	LVD Directive – 2014/35/EU EN 61010: 2010 + A1:2019 Clause 5,6,7,8,9,10,11,12,13,14,15,16 & 17
Electromagnetic Compatibility	EMC Directive – 2014/30/EU Conducted emissions: EN 55011:2009 + A1:2010 Radiated emissions: EN 55011:2009 + A1:2010 Voltage Fluctuations (Composite Video and USB Mode): EN 61000-3-3:2013 Electrostatic Discharge (Composite Video and USB Mode) EN 61000-4-2:2009 EFT/Bursts (Composite Video and USB Mode) EN 61000-4-4:2004 + A1:2010 Surge Immunity (Composite Video and USB Mode) EN 61000-4-5:2006 Conducted Immunity (Composite Video and USB Mode) EN 61000-4-6:2009 Dips & Interruptions (Composite Video and USB Mode) EN 61000-4-11:2004
Radio performance	N/A
RoHS	RoHS - Directive 2011/65/EU, as amended (by Directive 2015/863)

I hereby declare that the equipment named above has been designed to comply with the relevant sections of the above referenced Standards.

Signed Nick Hull
Position Managing Director
Location Limbs & Things, Bristol, England
Signature 
Date 17 NOVEMBER 2021



DECLARATION OF CONFORMITY

In accordance with UK Government Guidance

We at
Limbs & Things Ltd

of

Sussex Street, St. Philips, Bristol, BS2 0RA

Declare under our sole responsibility that the product described below:

Brand and Model Name	FLS (Fundamentals of Laparoscopic Surgery) Trainer, Part numbers: 50301,50302, 50306
----------------------	--

Has been tested and is in conformity with the following standards:

SUBJECT	STANDARD
Electrical Safety	Electrical Equipment (Safety) Regulations 2016 BS EN 61010: 2010 + A1:2019 Clause 5,6,7,8,9,10,11,12,13,14,15,16 & 17
Electromagnetic Compatibility	Electromagnetic Compatibility Regulations 2016 Conducted emissions: BS EN 55011:2009 + A1:2010 Radiated emissions: BS EN 55011:2009 + A1:2010 Voltage Fluctuations (Composite Video and USB Mode): BS EN 61000-3-3:2013 Electrostatic Discharge (Composite Video and USB Mode) BS EN 61000-4-2:2009 EFT/Bursts (Composite Video and USB Mode) BS EN 61000-4-4:2004 + A1:2010 Surge Immunity (Composite Video and USB Mode) BS EN 61000-4-5:2006 Conducted Immunity (Composite Video and USB Mode) BS EN 61000-4-6:2009 Dips & Interruptions (Composite Video and USB Mode) BS EN 61000-4-11:2004
Radio performance	N/A
RoHS	The Restriction of the use of certain Hazardous Substances in Electrical and Electronic Equipment Regulations 2012

I hereby declare that the equipment named above has been designed to comply with the relevant sections of the above referenced Standards.

Signed Nick Hull
Position Managing Director
Location Limbs & Things, Bristol, England
Signature 
Date 05/11/21



DECLARATION OF CONFORMITY

We at

Limbs & Things Ltd

of

Sussex Street, St. Philips, Bristol, BS2 0RA

Declare under our sole responsibility that the product described below:

Brand and Model Name	FLS (Fundamentals of Laparoscopic Surgery) Trainer, Part numbers: 50301,50302, 50306
-----------------------------	--

Has been tested and is in conformity with the following standards:

Technical regulations	FCC CFR47 Part 15:107 & 15: 109 Class B limits
Test laboratory	Kiwa Electrical Compliance Unit 8 Woodfieldside Business Park Pontllanfraith Blackwood United Kingdom NP12 2DG
Test report number	R20-5155
Test report date	07 th April 2020

Signed Nick Hull
Position Managing Director
Location Limbs & Things, Bristol, England

Signature

Date 17 NOVEMBER 2021

SAFETY & CLEANING INSTRUCTIONS

READ THE SAFETY INSTRUCTIONS CAREFULLY BEFORE USING YOUR FLS™ TRAINER SYSTEMS

DO's



Follow all instructions.
Keep these instructions.
Heed all warnings.

The product must be used by appropriately trained adults only.



Only use this product indoors.

Clean the product with a damp soft cloth or sponge, using only warm water with mild detergent.



If a product is damaged or worn, it should be repaired by Limbs & Things. To arrange this, please contact your point of purchase who will be able to provide a repair quote.

STORAGE & TRANSPORTATION



Do not install near any heat sources, do not expose the product to flames or use near naked flame sources. Do not use flammable solvents near or on this product.

Do not use the product near water, this product contains electronics.



Do not use any attachments other than those supplied by the manufacturer.

Do not disassemble the product or attempt to repair a faulty unit, please return the product to Limbs & Things for assessment and repair.



The product is not a toy and must not be used by children or untrained staff.



Always ensure that the products are properly packed and secured during transportation and storage in order to prevent personal injury or damage to the product.

SET UP

ATTACHING THE TROCARS

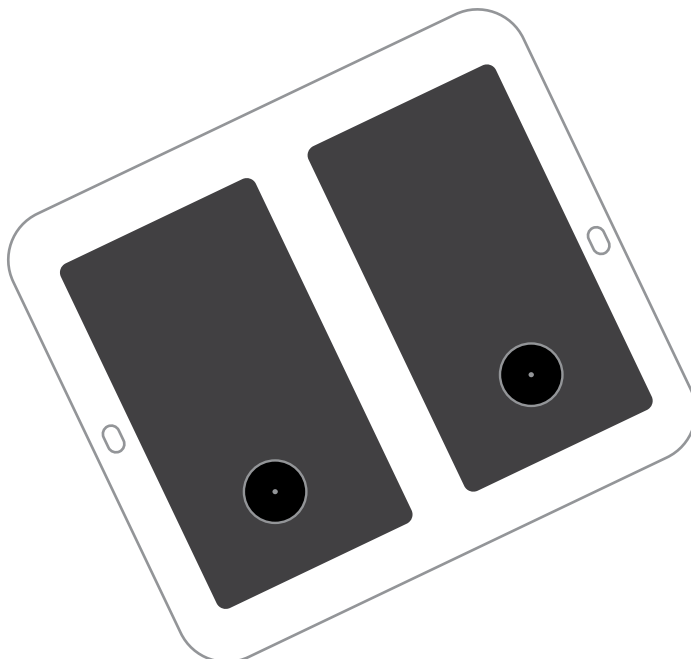
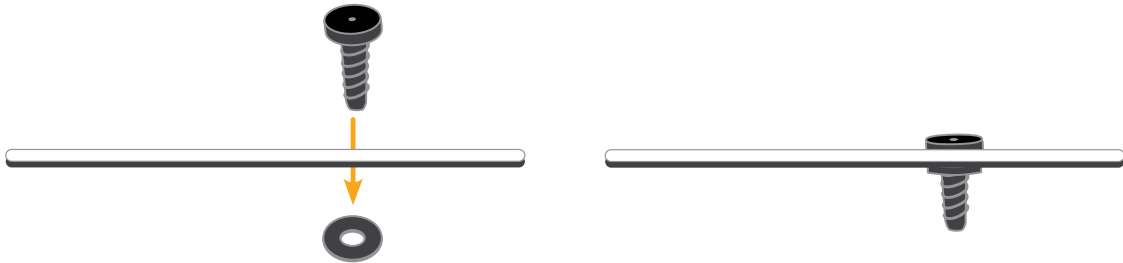

SET UP

ATTACHING THE FRAME

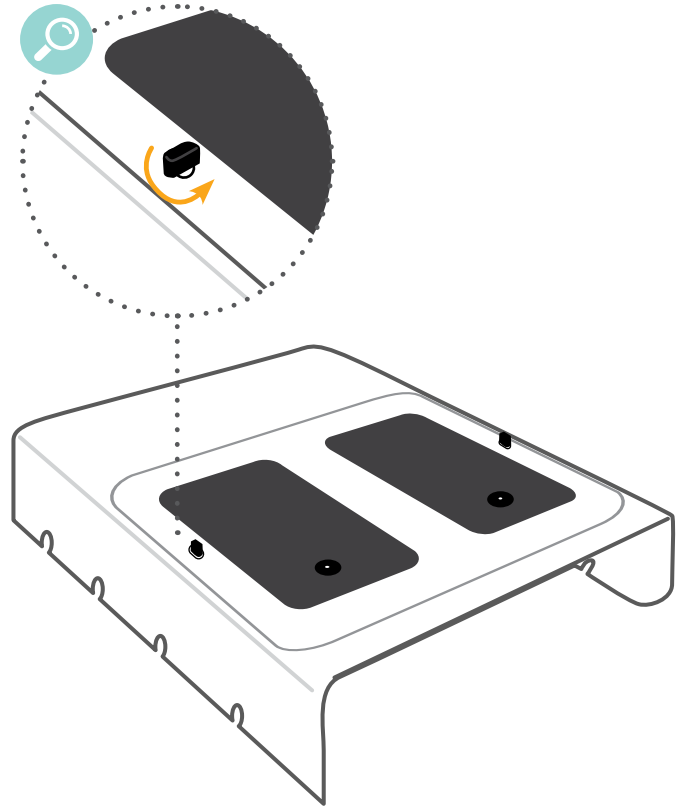
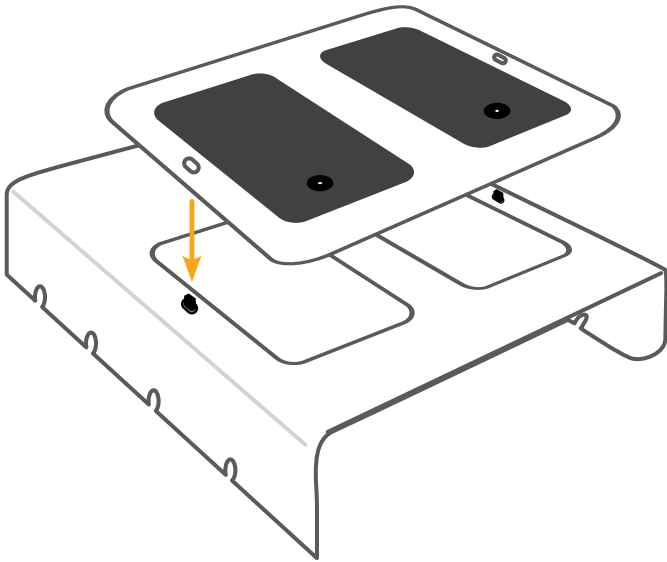

ASSEMBLING THE TRAINER BOX

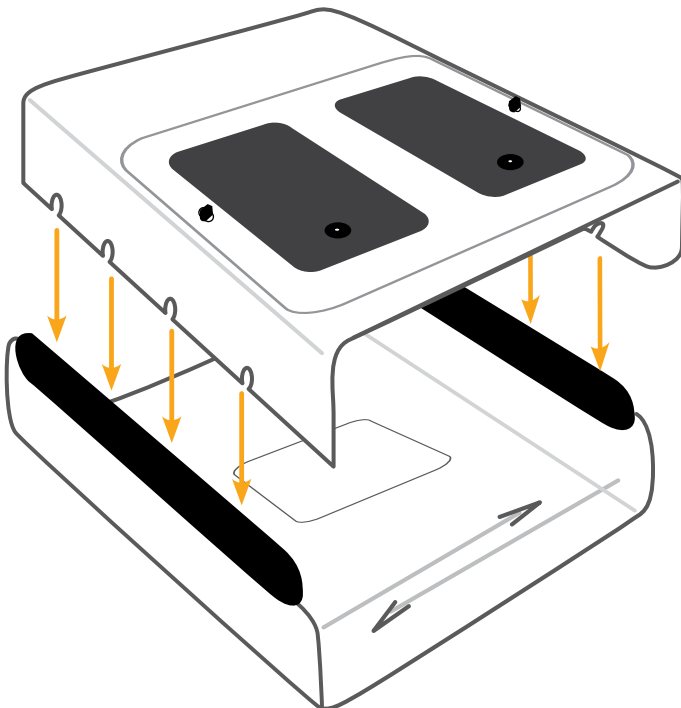

SET UP

CONNECTING THE MONITOR

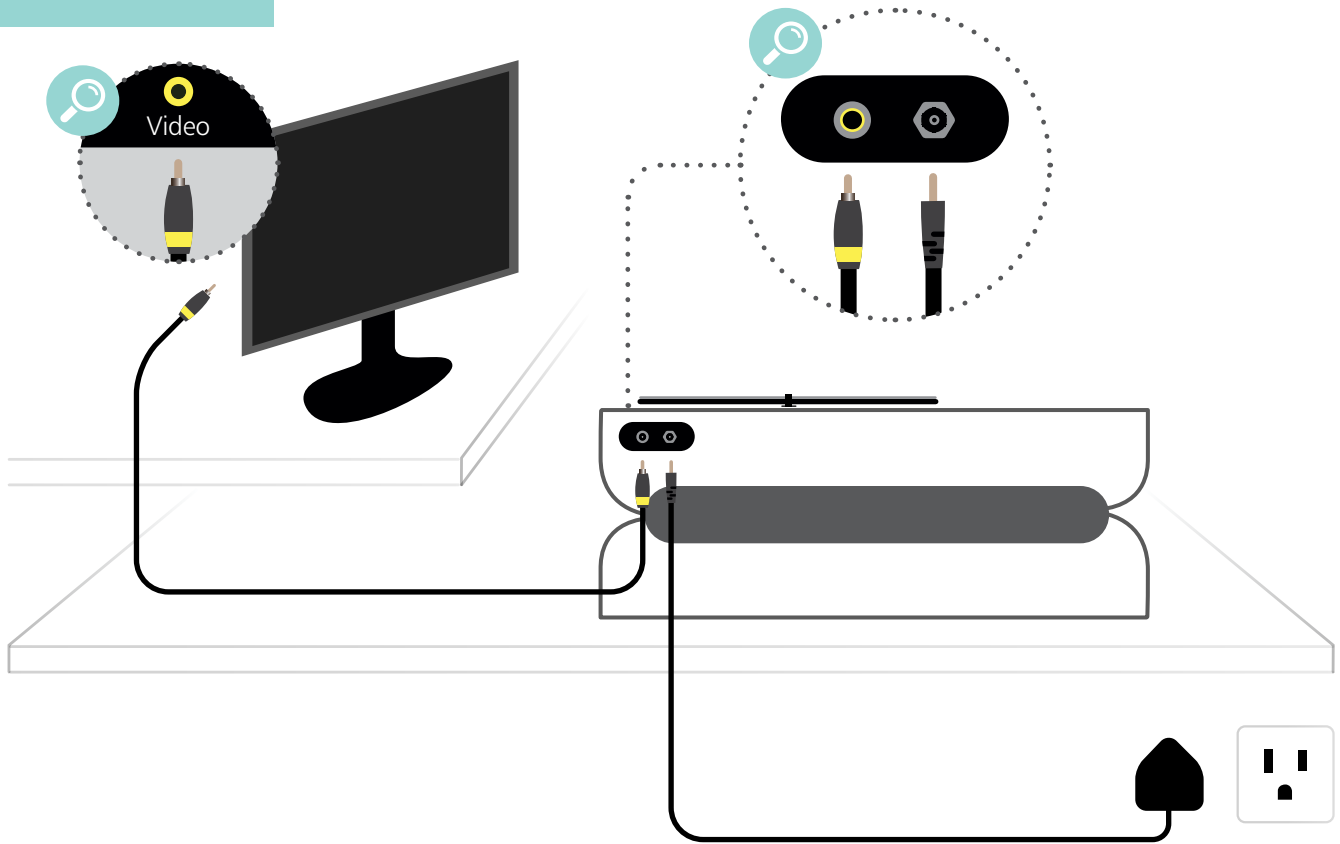

1

Turn TV on

Power



[If monitor is not displaying the correct channel]

2

Press 'Source' and select **AV**

Source



[After a few seconds the AV channel will display the camera view]

TIPS

ADJUSTING THE CAMERA TO CENTER THE IMAGE

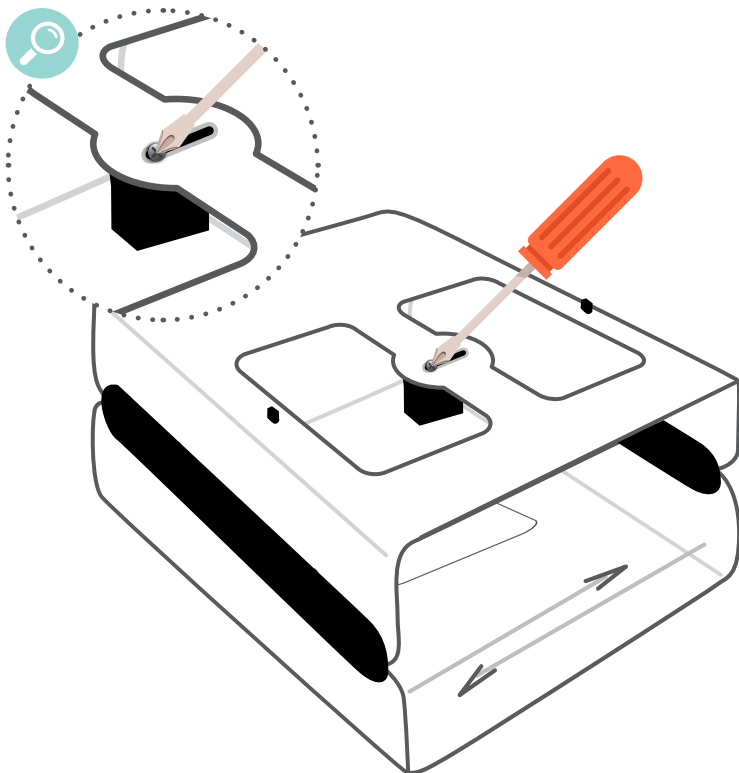
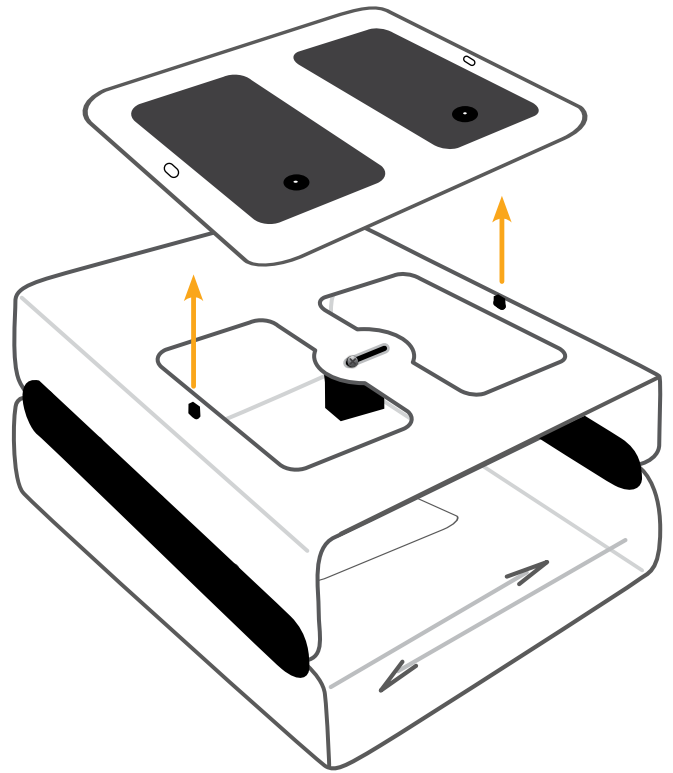
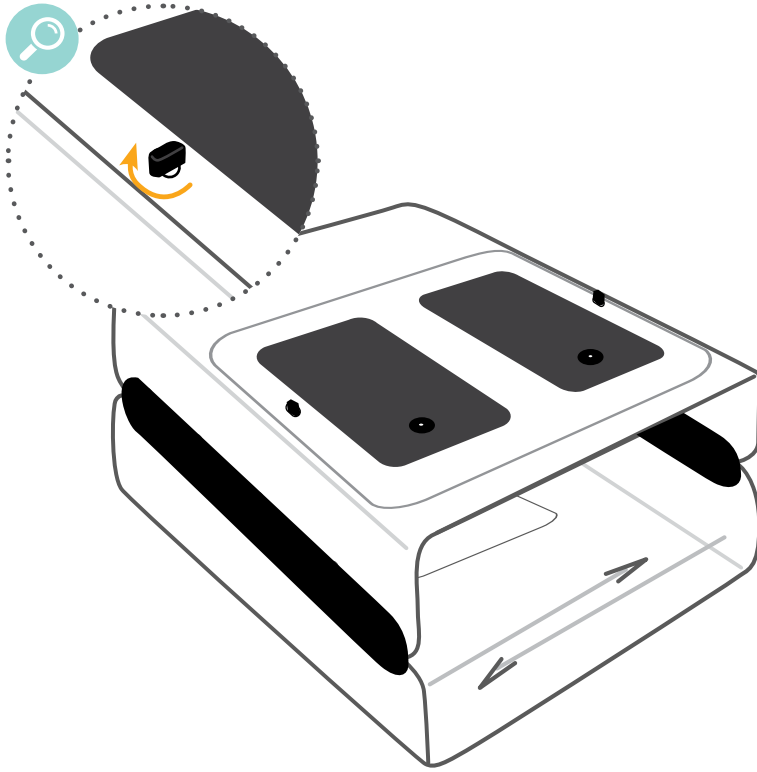

Slide the screw to the preferred position

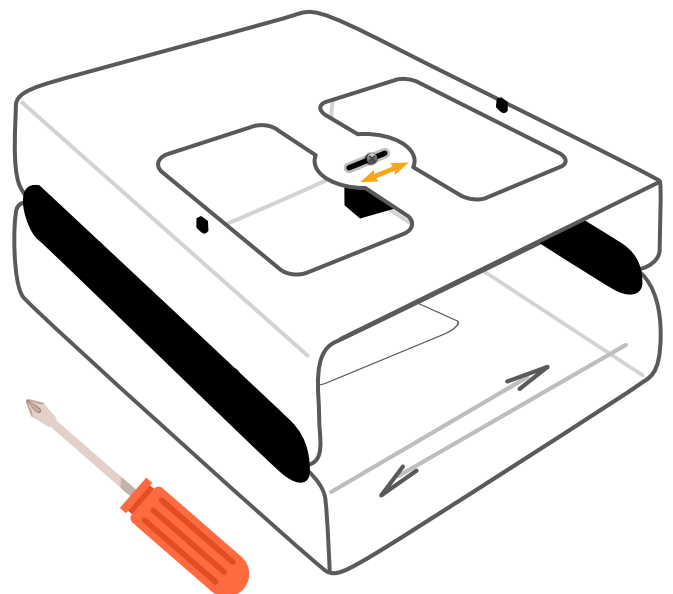

TIPS

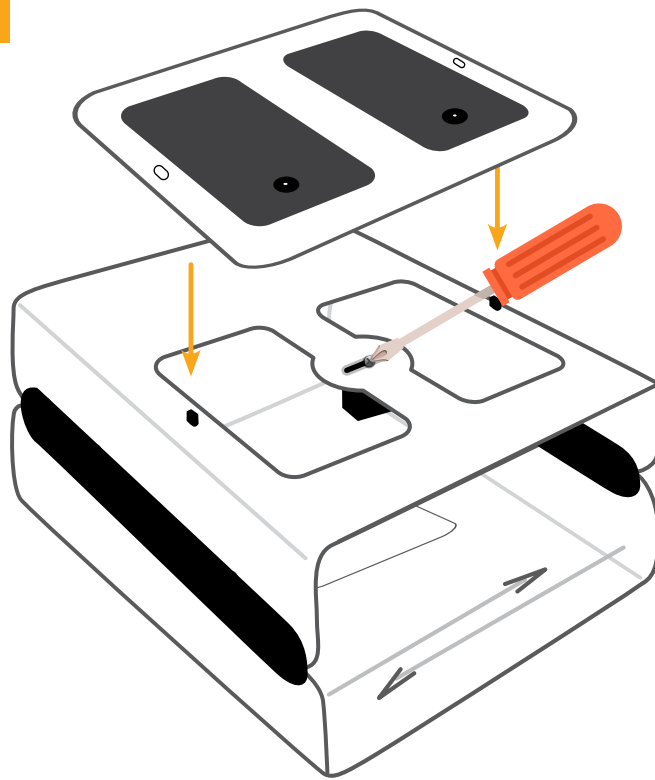

Tighten the screw and re-attach the frame

REMOVE PLASTIC CAP

Ensure the cap covering the camera lens is removed before use

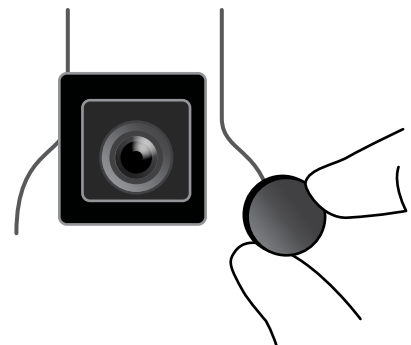
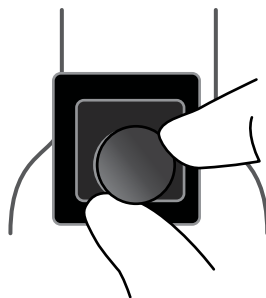
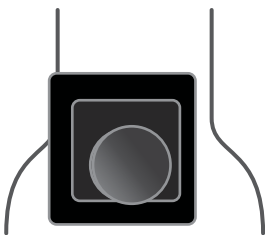
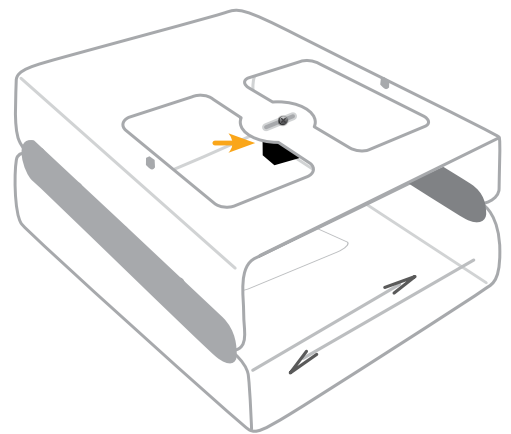

YOU MAY
ALSO BE
INTERESTED IN...

FLS CONVERTER BUNDLE

50370



CONSUMABLES

Penrose Drains
(Pack of 100)

50366

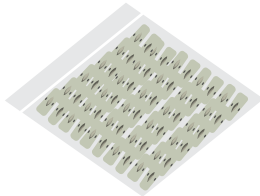

Foam Organs
(Pack of 15)

50363



Gauze Pads with Single Circle
(Pack of 100)

50361

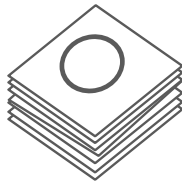

Gauze Pads with Double Circle
(Pack of 100)

50362

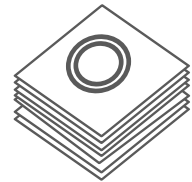

Single Use Ligating Loop
(Pack of 3)

50364

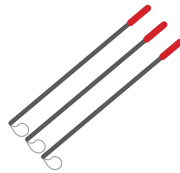

Multi-Use Ligating Loop
(Pack of 5)

50365

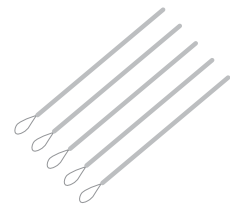

FLS APPROVED INSTRUMENT KIT

(8 Pieces)

50380

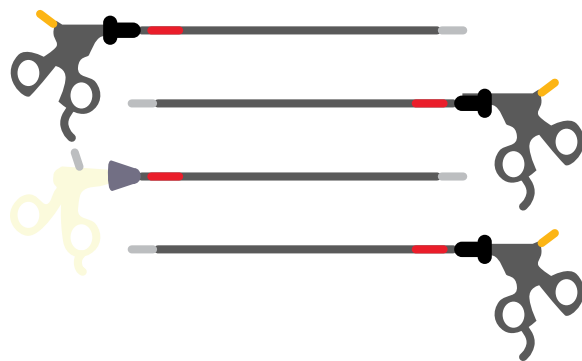
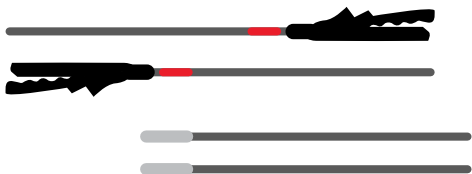

Part No: 065-701

Issue 13 - November 2021
© 2021 Limbs & Things